

Ventilation grille

B3020



Description

B3020 is a rectangular aluminium grille with fixed horizontal bars. B3020 is used for both supply and exhaust air, and is supplied as standard with springs for installation in plenum boxes type VBA, WB or mounting frame type GGR. B3020 can also be used with volume regulator GAT.

Maintenance

The grille should be removed to gain access to the plenum box or duct. The external parts should be wiped with a damp cloth.

Accessories

Plenum box: VBA, WB
 Mounting frame: GGR
 Volume regulator: GAT

Order code

Product	B 3020	aaa	bbb
Type			
A - measure			
B - measure			

Dimensions

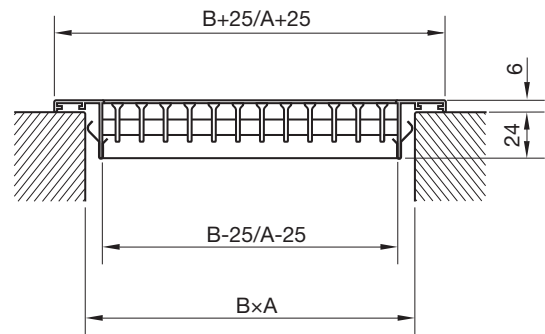

A x B mm	Free area F (m ²)	Weight kg
200 x 100	0,0072	0,3
300 x 100	0,0113	0,4
400 x 100	0,0155	0,5
500 x 100	0,0195	0,7
300 x 150	0,0189	0,6
400 x 150	0,0258	0,7
500 x 150	0,0326	1,0
600 x 150	0,0395	1,2
400 x 200	0,0361	0,8
500 x 200	0,0457	1,4
600 x 200	0,0553	1,6

Other sizes and types can be supplied - see special grille B.

Materials and finish

Grille: Aluminium
 Standard finish: Natural anodised
 On request: RAL 9010, gloss 30

The grille is available in other colours. Please contact Lindab's sales department for further information.

Special grille

B



Description

Special grille type B is a range of aluminium grilles with fixed bars. The grille can be configured on the basis of the summary on the following pages. As part of the configuration you can select frame, grids, type of mounting and accessories. Finally the A x B dimension is specified. Please note that the A x B dimension varies according to the frame selected. A x B dimensions have certain limitations, which are shown under the order code.

Materials and finish

Grille: Aluminium
 Standard finish: Natural anodized
 On request: RAL 9010 Gloss 30

The grille is available in other colours. Please contact Lindab's sales department for further information.

Order code

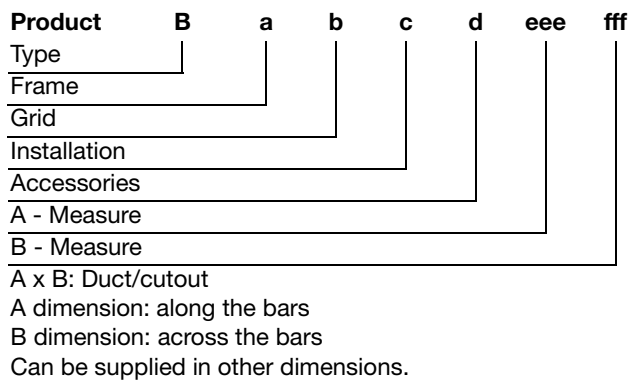

Max. A x B = 2000 x 1000
 Min. A x B = 60 x 60
 Free area F [m²] = (A-25) x (B-25) x 0.55 x 10⁻⁶

Mounting frame and volume regulator - see GGR/GAT.

Frame

1 No frame

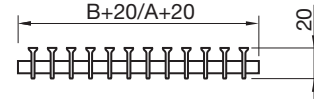

2 No frame

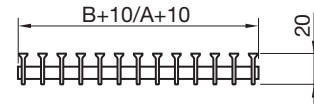

3 With 25 mm flange - wall/ceiling

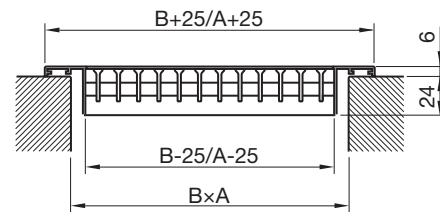

4 With flange - floor

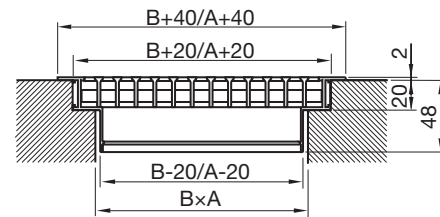

5 With Z frame - wall

6 With Z frame - floor

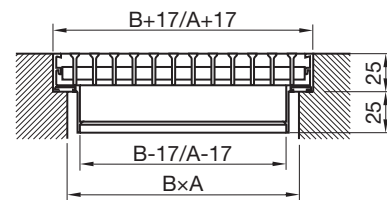

7 With angle frame - wall

8 With angle frame - floor

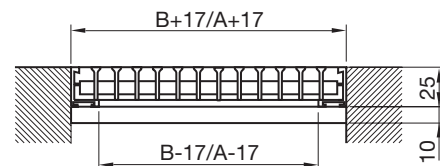

9 Special floor frame, only design 9600

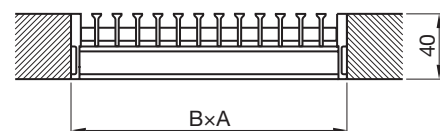

Special grille

B

Grid

0 0° Free area: 55%

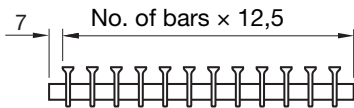

1 30° bend Free area: 55%

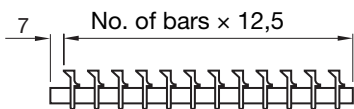

2 0° Free area: 70%

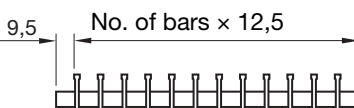

3 15° bend Free area: 70%

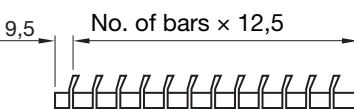

4 0° Free area: 60%

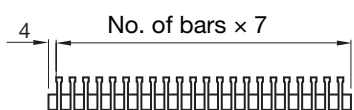

5 0° Free area: 75%

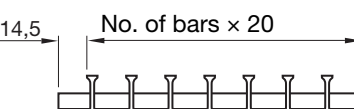

6 0° Free area: 55%

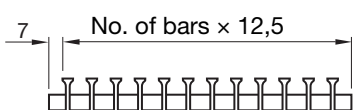

Mounting

0 Not prepared for mounting



1 Screw holes, only frame 3

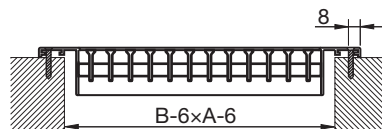

2 With clamp springs. -only frame 3.



3 Mounting frame and springs -only frame 3



4 Frame types 5-6-7-8 with wall anchors

8 Hidden screws. - only frame 3



Accessories

0 No accessories

1 Direction control

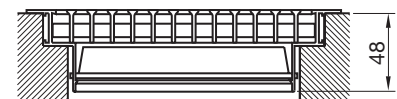
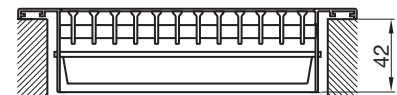

2 Volume control damper

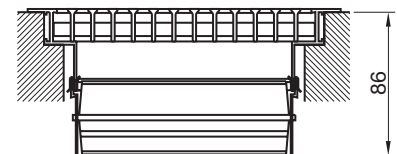
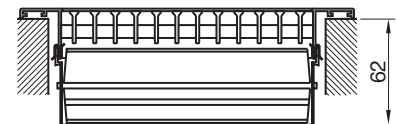

3 Direction and volume control damper

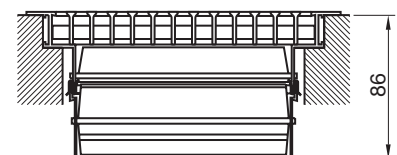
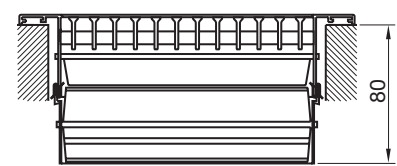

Direction and volume control damper only possible with frame types 3-4-5 and 6.

1
2
3
4
5
6
7
8
9
10
11
12
13
14
15
16
17
18

Ventilation grille/Special grille

B3020/B

Technical data

Capacity

Volume flow q_v [l/s] and [m³/h], total pressure drop Δp_t [Pa], throw $l_{0,2}$ [m] and sound level L_{WA} [dB(A)] can be seen in the diagrams.

Throw $l_{0,2}$

Throw $l_{0,2}$ [m] at an average speed of 0.2 m/s, 0° bar setting without ceiling effect (distance from diffuser to grille over 800 mm) can be seen in the diagrams. Correction for dispersal - see table below.

Bar setting	45°	90°
Correction factor	0,8	0,5

Sound effect level L_{WA}

Sound effect level L_{WA} [dB(A)] at 0° bar setting can be seen in the diagrams. The sound levels apply for grilles without a volume regulator. See the table below for correction of sound level on dispersal [dB].

Bar setting	45°	90°
Correction factor	+3	+10

Frequency-related sound effect level

The sound effect level in the frequency band is defined as $L_{WA} + K_{Ok}$. The K_{Ok} values are given in chart. See table below.

	Centre frequency Hz							
	63	125	250	500	1K	2K	4K	8K
Supply air	1	-4	-2	0	-6	-10	-14	-19
Exhaust	-3	-8	-3	-1	-3	-12	-19	-22

Volume regulator GAT

Correction of total pressure p_t [Pa] and sound effect level L_{WA} [dB(A)] using volume regulator. See table below.

Supply air	Open	45°	Closed
Pressure [Pa]	x1,3	x3	x12
Sound power level [dB(A)]	+5	+12	+32

Exhaust	Open	45°	Closed
Pressure [Pa]	x1,3	x3	x10
Sound power level [dB(A)]	+3	+12	+30

Dimensioning diagram – supply air

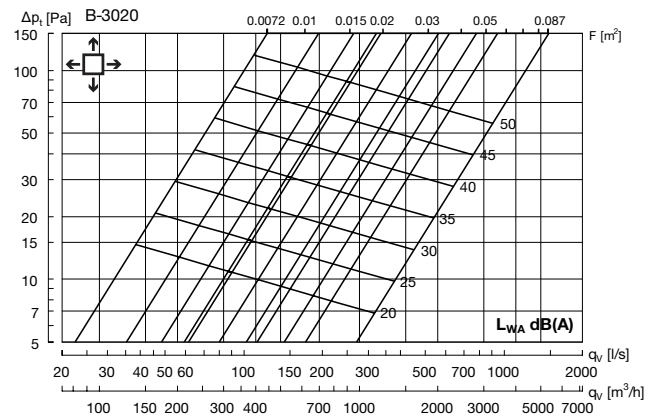

Dimensioning diagram - exhaust

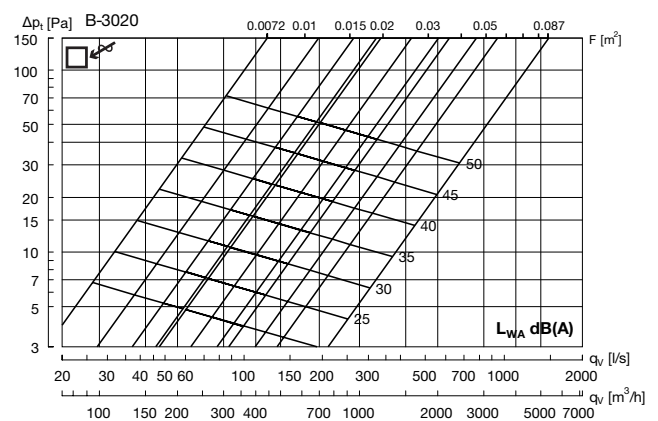

Throw

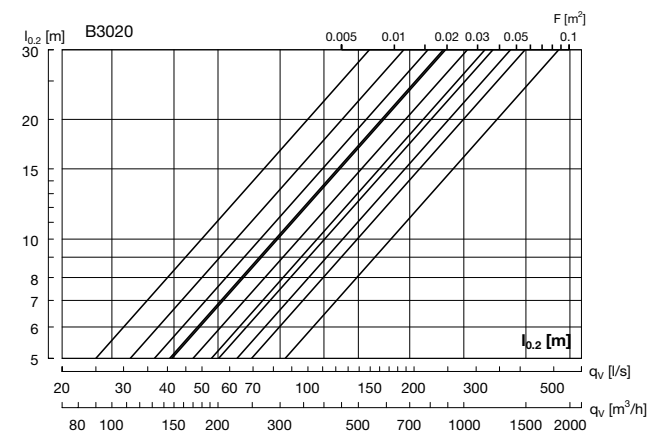

- 1
- 2
- 3
- 4
- 5
- 6
- 7
- 8
- 9
- 10
- 11
- 12
- 13
- 14
- 15
- 16
- 17
- 18