

Linear diffuser

MTL

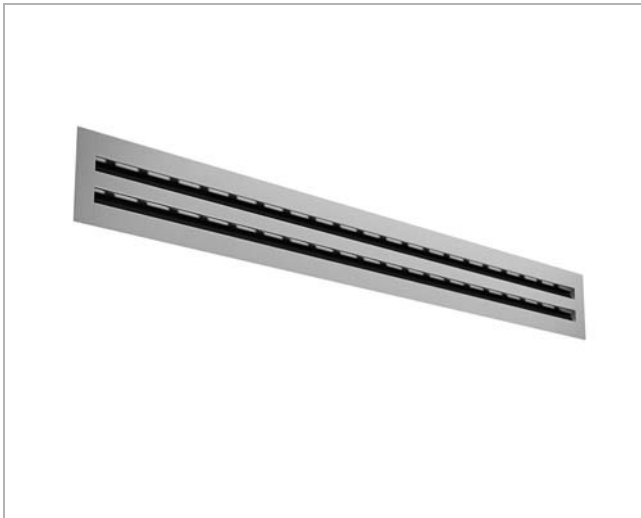

Description

MTL is a rectangular linear diffuser in aluminium. MTL is suitable for both supply and exhaust air. MTL is equipped with air guide baffles, making it possible to use MTL for horizontal supply air.

The horizontal dispersal pattern can be easily changed without the use of tools by turning the air guide baffle. The air guide baffle must be removed for vertical supply air.

MTL can be supplied in two versions, 15 mm or 19 mm, depending on capacity requirements or aesthetic considerations. MTL can be installed with plenum box STB/STU in order to achieve an even flow and individual adjustment.

MTL is normally supplied in lengths up to max. 2 m, but can be supplied on request up to 5 m. MTZ-1 is a 90° joint, when an aesthetically pleasing corner is required.

- Discrete appearance
- Used for both supply air and exhaust
- Horizontal and vertical supply air.

Maintenance

MTL can be removed to enable cleaning of internal parts or to gain access to the duct or box.

The visible parts of the diffuser can be wiped with a damp cloth.

Order code

Product	MTL	aa	b	cccc
Type				
Slot size	15			
	19			
No. of slots				
Length (L)				

Dimensions

MTL-15-2

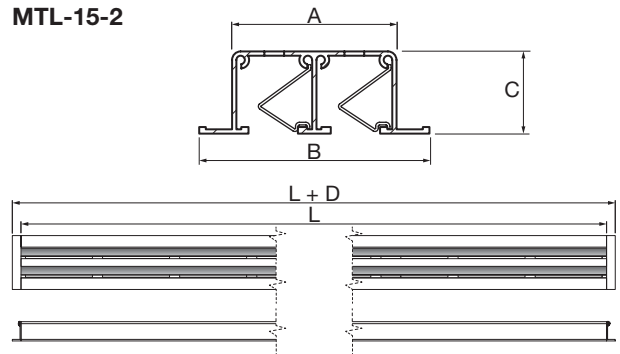

MTL-19-2

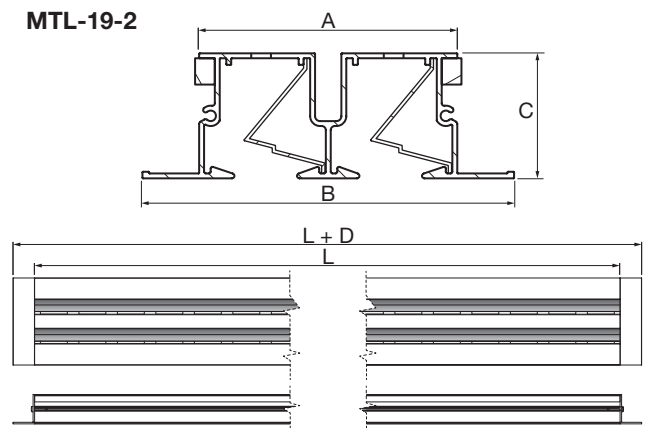

Both ends are equipped with flanges.

Slot width: 15 mm

No. of slots	A mm	B mm	C mm	D mm
1	25	45	25	30
2	50	70	25	30
3	75	95	25	30
4	100	120	25	30

Cutout: A + 10 mm x L + 10 mm

Slot width: 19 mm

No. of slots	A mm	B mm	C mm	D mm
1	40	75	38	56
2	79	113	38	56
3	117	151	38	56
4	157	189	38	56

Cutout: A + 20 mm x L + 20 mm

Materials and finish

Slot: Aluminium
 Standard finish: Natural anodised
 Air guide baffle: Black ABS plastic

The diffuser is available in other colours. Please contact Lindab's sales department for further information.

Linear diffuser

MTL

Accessories

MTZ-1

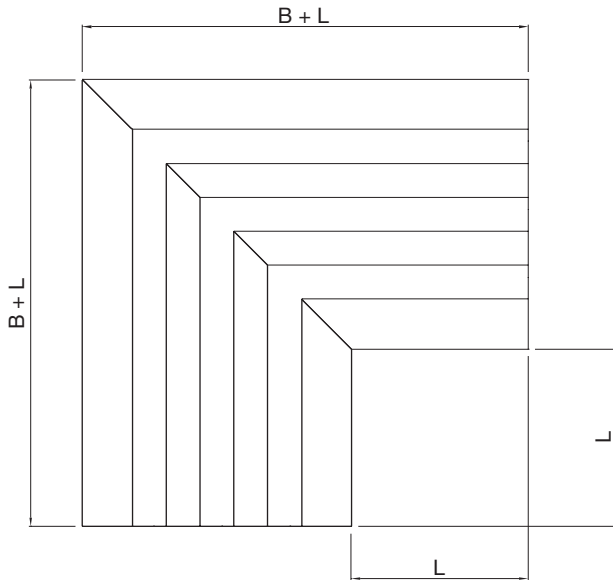

MTZ-1 15	L	B	MTZ-1 19	L	B
1	150	45	1	150	75
2	150	70	2	150	113
3	150	95	3	150	151
4	150	120	4	150	189

MTZ is supplied as two mitred ends (not one piece).

Ordering example

Product Type	MTZ-1	aa	b
Slot size	15		
	19		
No. of slots			

Installation in plenum box STB/STU

A self-tapping screw is fitted through the slot up into the perforated surface of the plenum box.

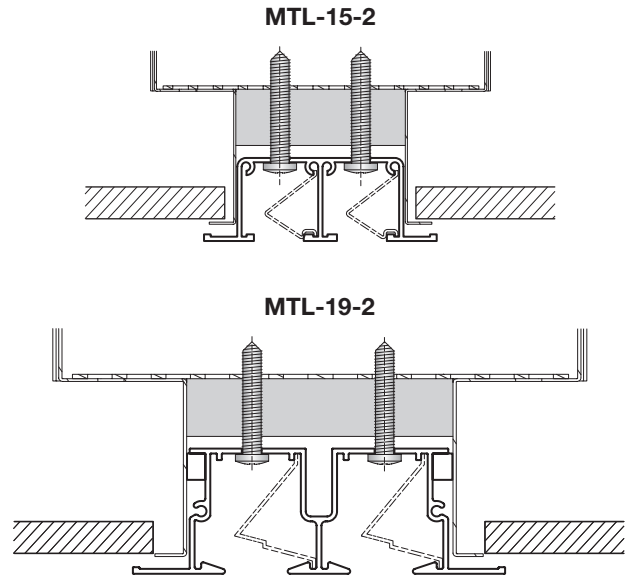

Installation of slots in continuous strips

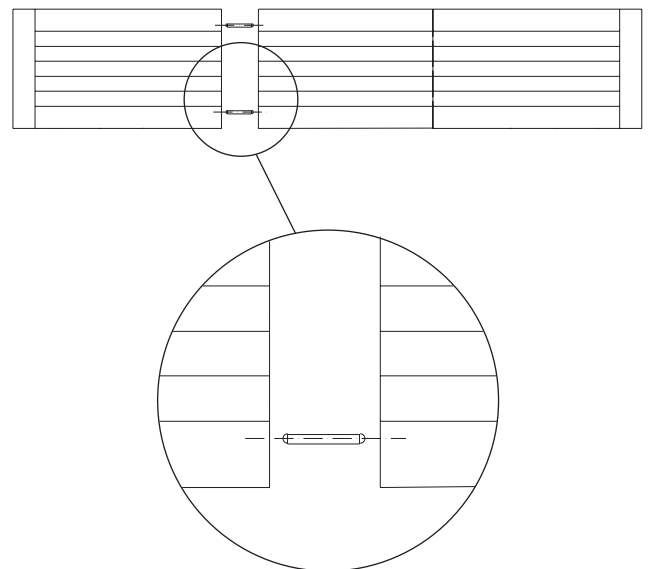

The slots are often installed in continuous strips, where there is a need to join the slots, so that it resembles a single piece.

In these cases, the full length must be specified when ordering, and the slots will be supplied adjusted to the total length.

The outermost pieces will be equipped with end pieces, and the middle pieces will be supplied without end pieces. The slots are joined using the accompanying pins.

Linear diffuser

MTL

Technical data

Capacity

Volume flow q_v [l/s] and [m³/h], total pressure Δp_t [Pa], throw $l_{0,2}$ [m] and sound power level L_{WA} [dB(A)] can be seen in the diagrams.

Throw $l_{0,2}$

Throw $l_{0,2}$ [m] at a speed of 0.2 m/s and 1 m slot length can be seen in the diagrams. Correction of throw at other slot lengths: see table 1.

Table 1: Correction of throw

Slot length	250	500	1000	1500	3000
Correction factor	0,7	0,85	1	1,1	1,2

Frequency-related sound effect level

The sound effect level in the frequency band is defined as $L_{WA} + K_{ok}$.
 K_{ok} values for MTL with box - see table 2.A and 2.B below.

Table 2.A: K_{ok} values [dB] for MTL with sloth width 15.

MTL-15-x + Box No. of slots (x)	Mean frequency Hz							
	63	125	250	500	1K	2K	4K	8K
1	8	3	6	-3	-10	-19	-27	-31
2	6	-1	5	-2	-8	-15	-23	-33
3	8	1	6	-2	-8	-17	-24	-31
4	6	-1	6	-2	-8	-15	-23	-31

Table 2.B: K_{ok} values [dB] for MTL with sloth width 19.

MTL-19-x + Box No. of slots (x)	Mean frequency Hz							
	63	125	250	500	1K	2K	4K	8K
1	11	8	6	-4	-12	-16	-23	-28
2	10	4	6	-4	-10	-15	-22	-28
3	8	2	7	-4	-11	-18	-24	-28
4	9	3	6	-3	-10	-16	-23	-27

Table 3: Correction for other slot lengths

Slot length	250	500	1000	1500	3000
correction [dB(A)]	-6	-3	0	2	5

Sound attenuation

Sound attenuation ΔL [dB] of MTL+STB including the end reflection, corresponding to the inlet diameter. See table 4 below.

Table 4: Sound attenuation ΔL [dB]

No. of slots	Mean frequency Hz							
	63	125	250	500	1K	2K	4K	8K
1	19	15	11	12	8	10	11	10
2	18	14	9	11	9	9	10	10
3	15	10	7	9	8	8	9	10
4	14	10	7	8	8	7	8	9

Balancing

Balancing data for control of air volume is available in a separate brochure.

Sample calculation:

Required data: Volume of air 200 m³/h
Throw 6.5 m
Horizontal supply air
Slot length 1.5 m, i.e. 133 [(m³/h)/m]

Solution: MTL 19

2-slot version is selected:
Throw according to diagram: 5.8 m

Throw correction according to table 1:
 $1.1 \times 5.8 = 6.4$ m

Pressure loss and sound level according to diagram:

Open damper: 13 Pa, 15 dB(A)
Closed damper: 38 Pa, 22 dB(A)

Correction according to table 3:

Open damper: $15 + 2 = 17$ dB(A)
Closed damper: $22 + 2 = 24$ dB(A)

Linear diffuser

MTL

Technical data

Horizontal supply air

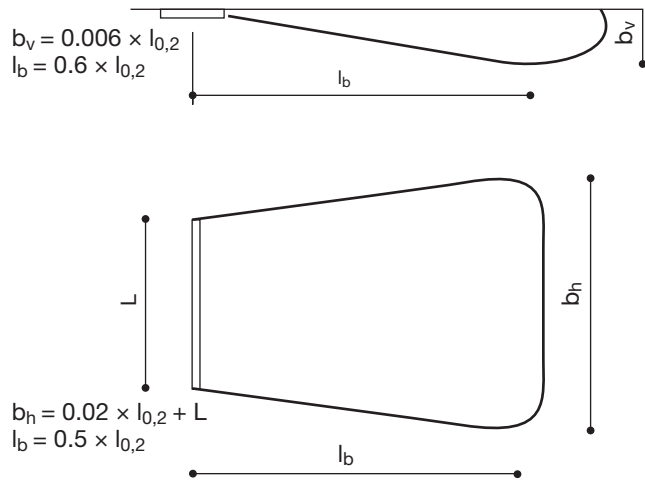

Vertical supply air

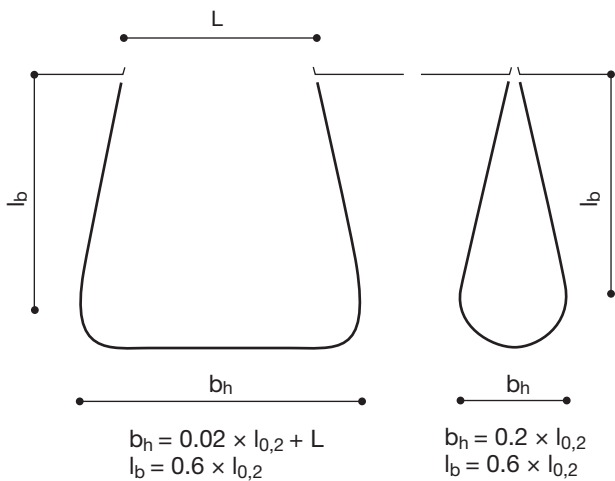

Throw MTL 15

Horizontal

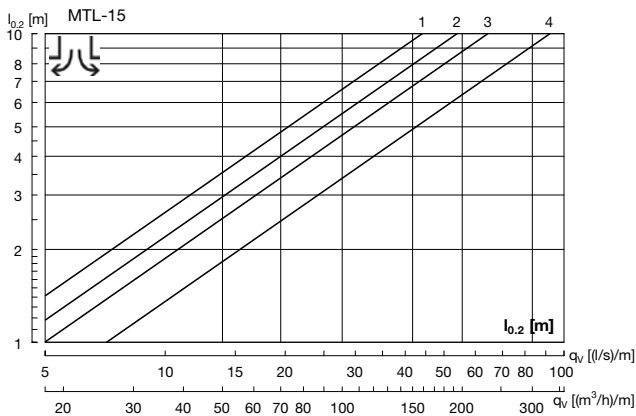

Vertical

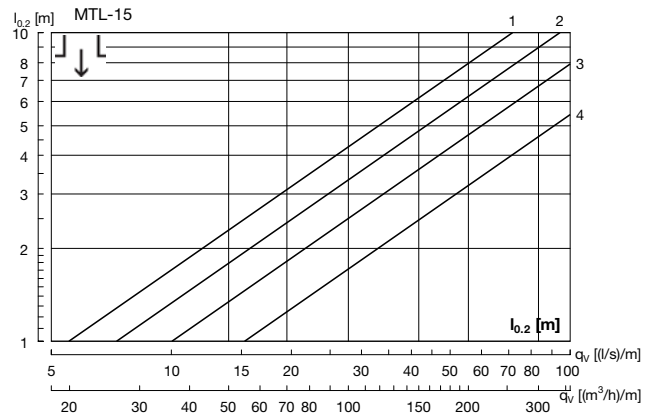

Throw MTL 19

Horizontal

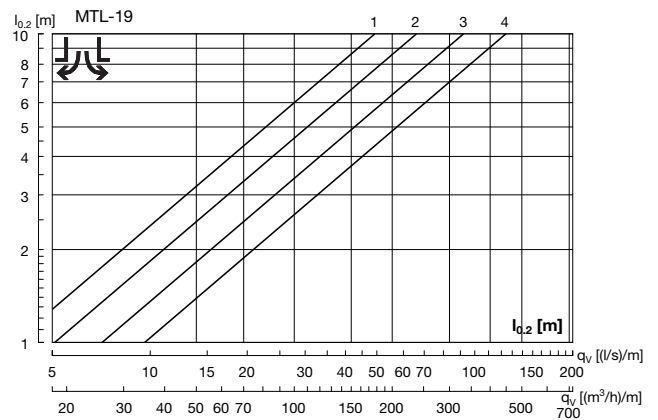

Vertical

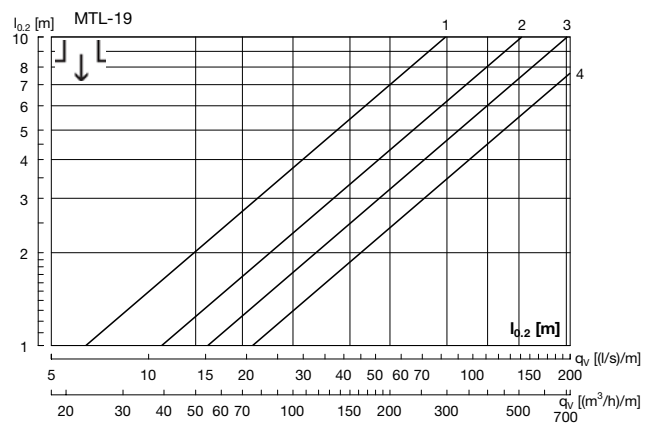

Linear diffuser

MTL

Horizontal-Supply

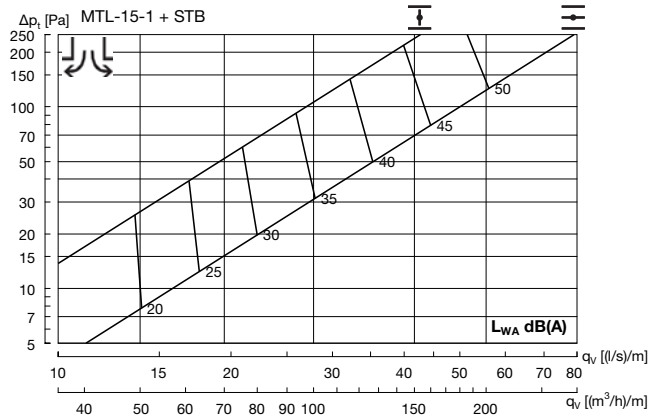

Vertical-Supply

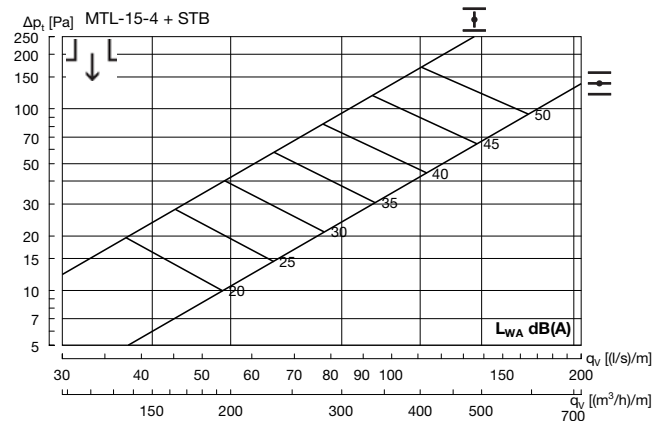
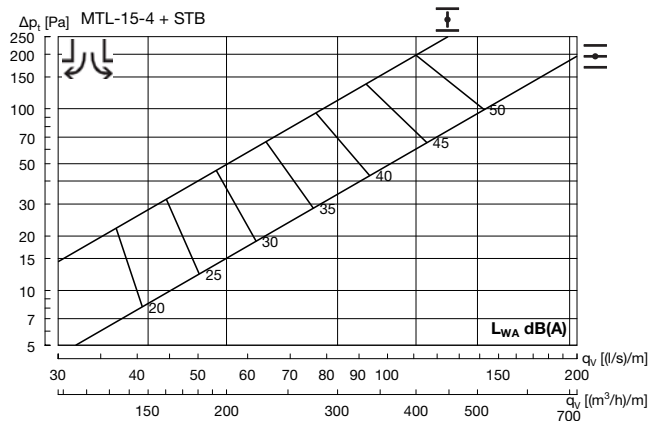
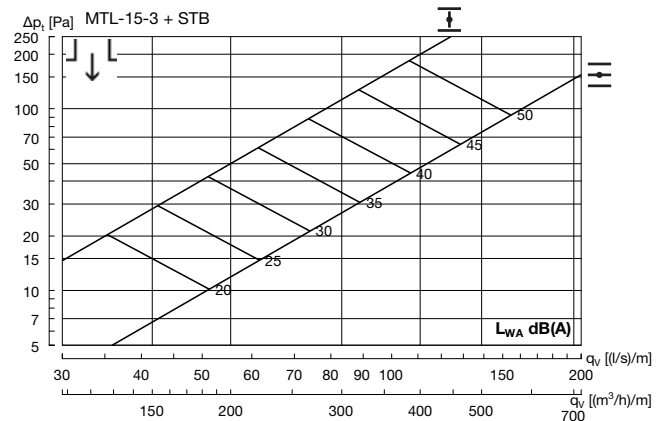
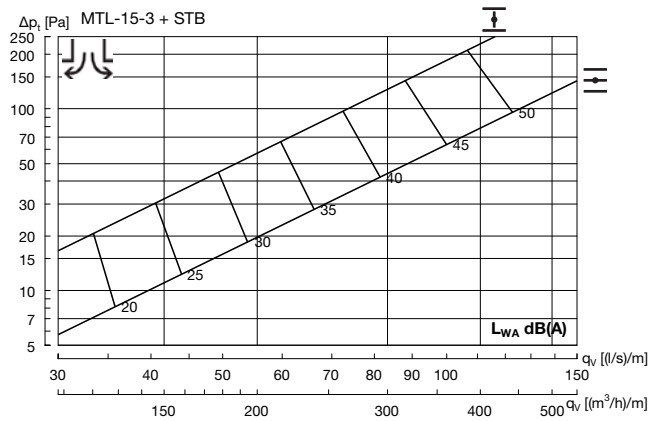
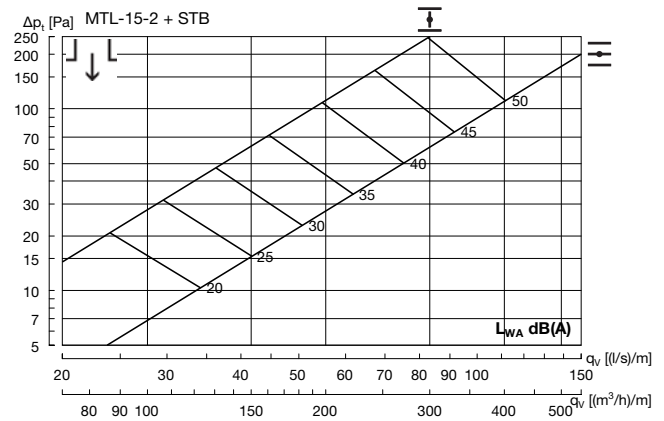
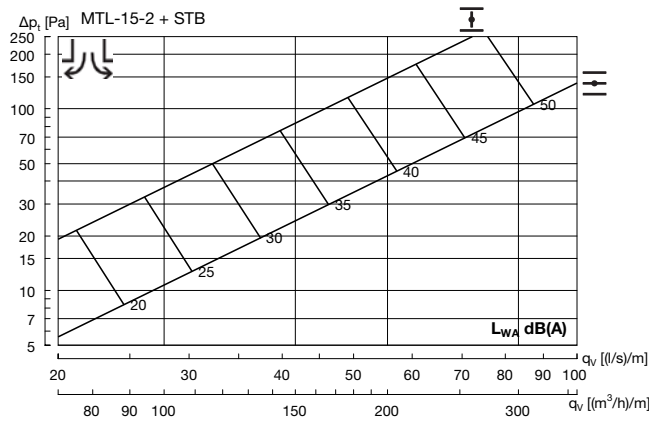
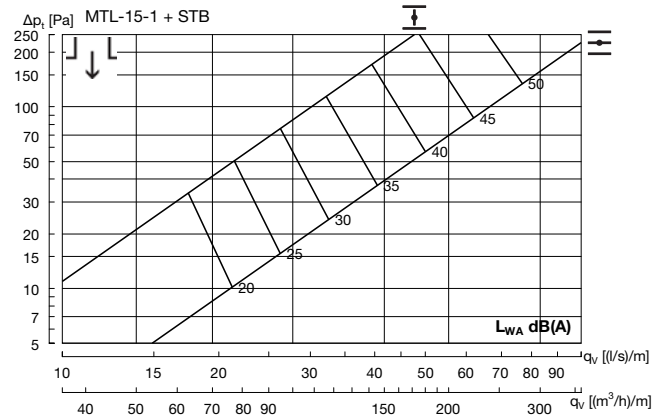

- 1
- 2
- 3
- 4
- 5
- 6
- 7
- 8
- 9
- 10
- 11
- 12
- 13
- 14
- 15
- 16
- 17
- 18

Linear diffuser

MTL

Horizontal-Supply

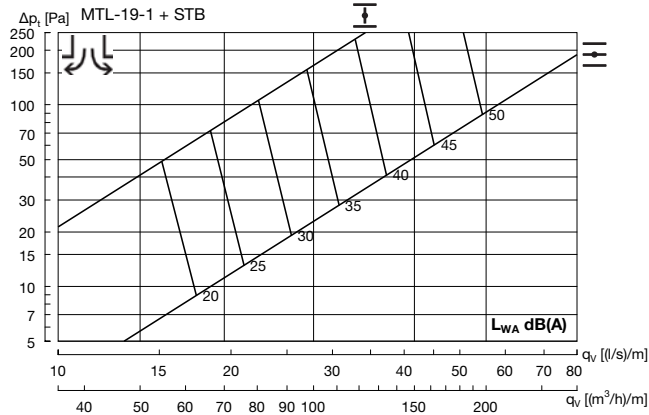

Vertical-Supply

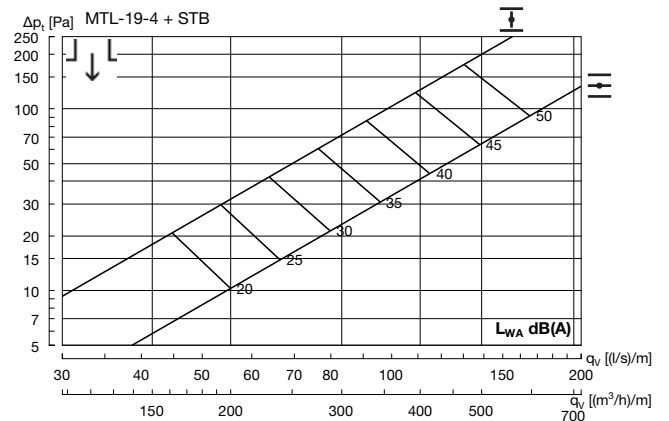
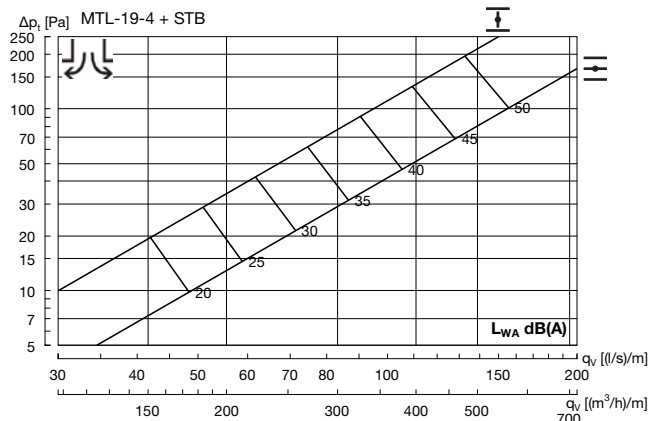
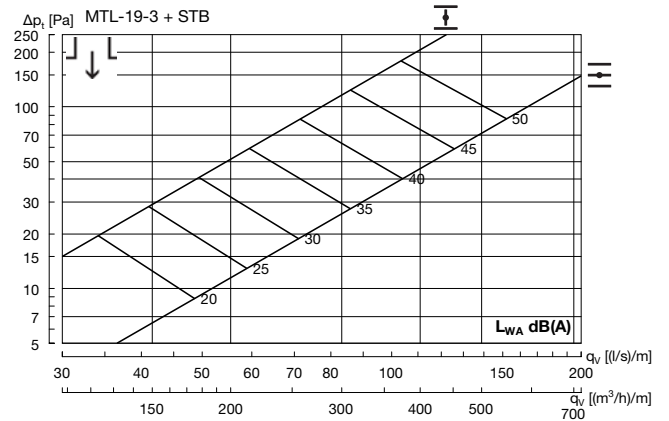
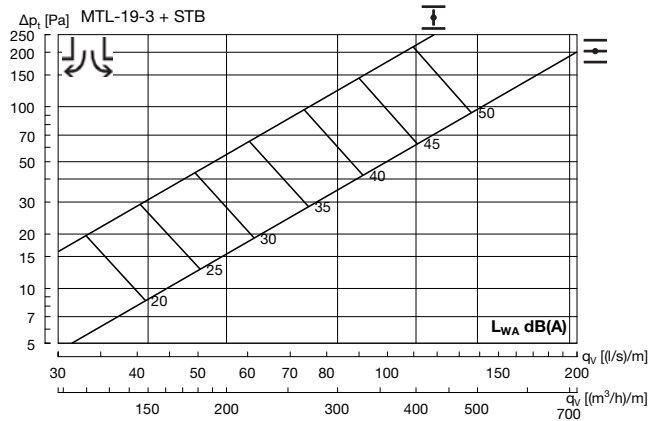
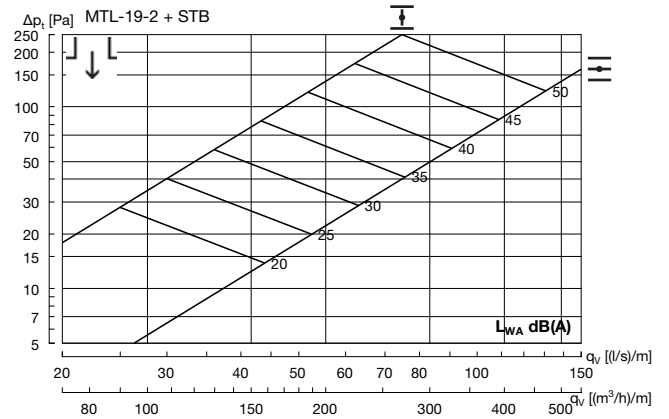
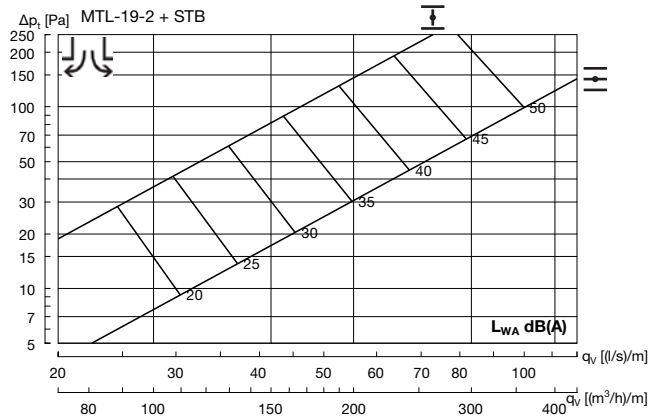
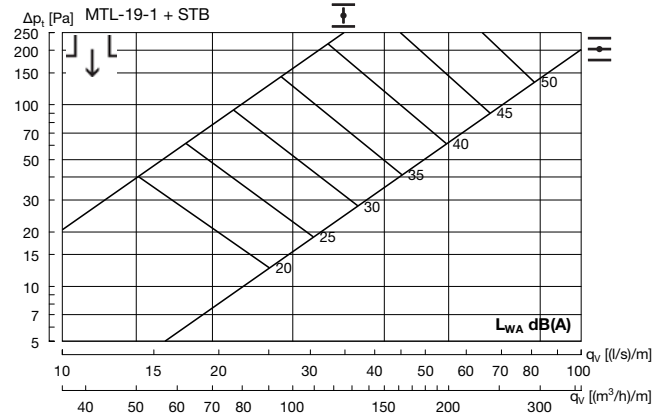

Linear diffuser

MTL

Exhaust air- MTL 15

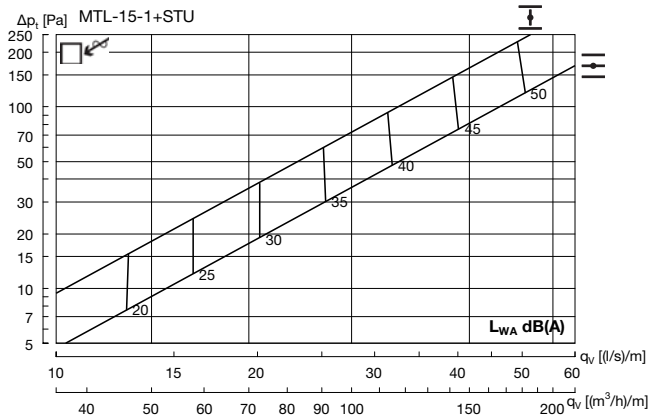

Exhaust air- MTL 19

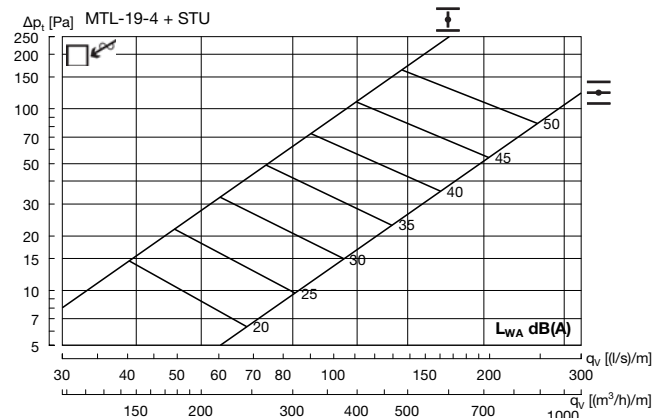
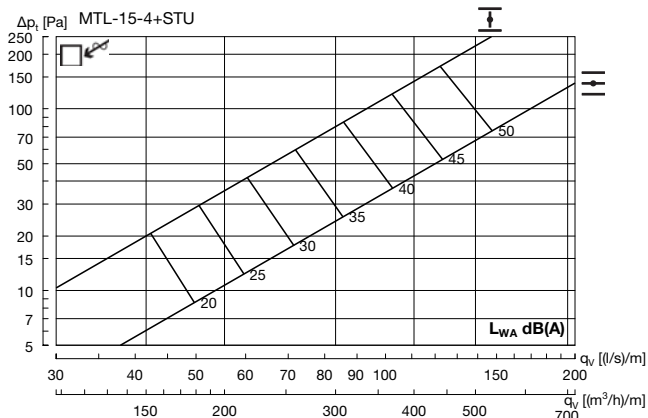
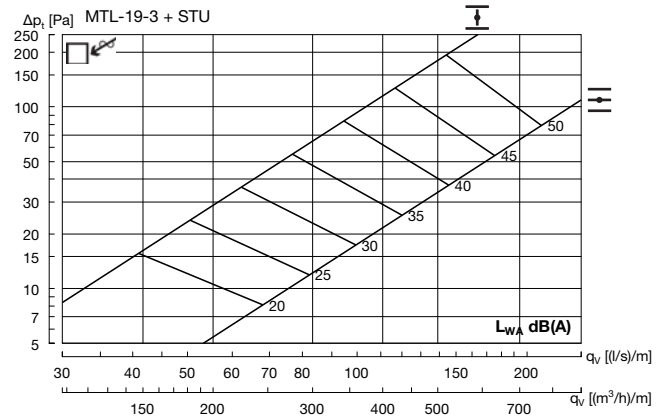
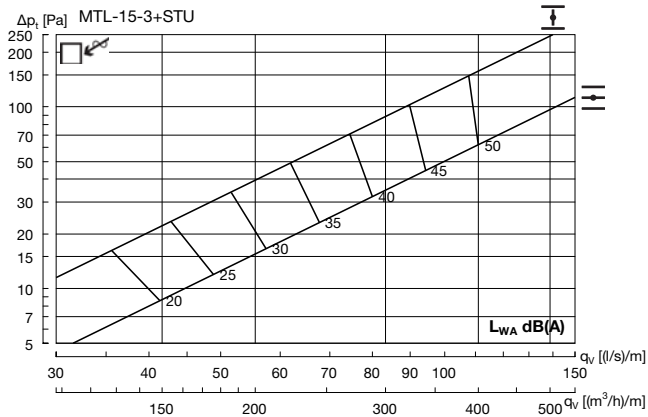
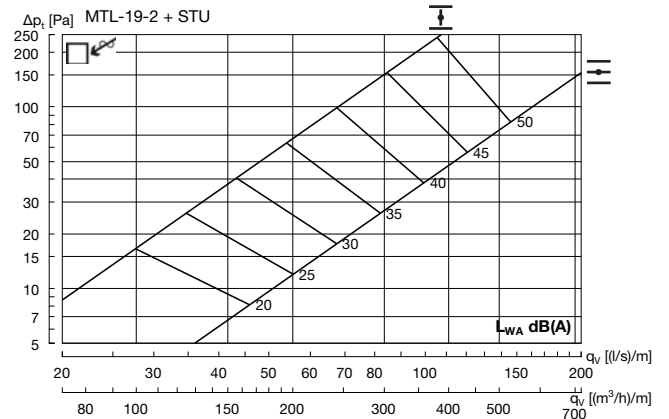
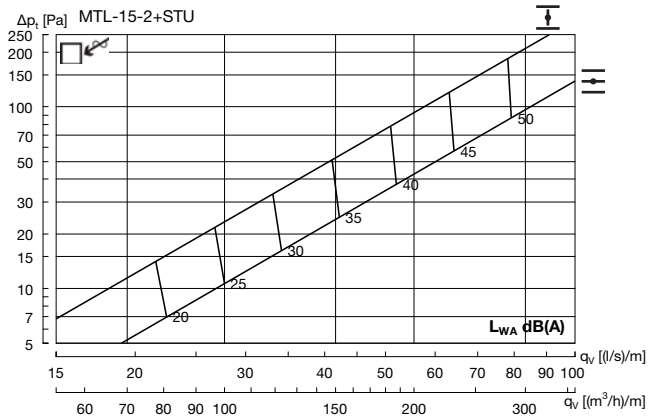
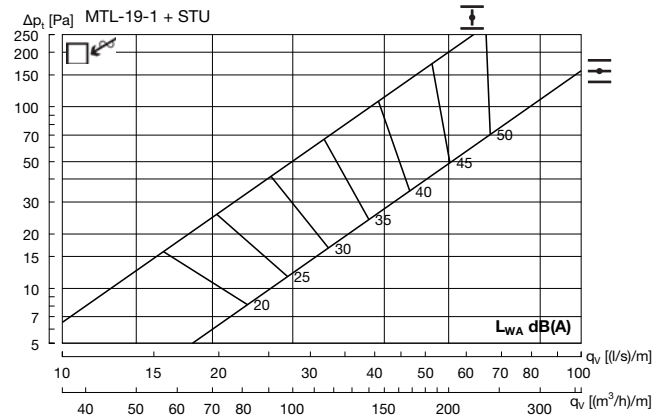

- 1
- 2
- 3
- 4
- 5**
- 6
- 7
- 8
- 9
- 10
- 11
- 12
- 13
- 14
- 15
- 16
- 17
- 18