

## ■ Floor Slot Diffusers LD-16N

### Application

LD-16N floor slot diffusers are a suitable solution for swimming pools and similar rooms with large glass surfaces and windows. They are designed for installation in the floor. Warm air is supplied in the upwards direction, towards the window. With appropriate dimensions, proper air supply is guaranteed, free of excessive draught or noise ( $L_{WA} < 35 \text{ dB(A)}$ ).

### Description

LD-16N slot diffusers are designed in 1, 2, 3, 4, 5 and 6 slot versions. They are made of fixed aluminium sections and an aluminium structural frame.

The diffusers are available in single piece lengths 200 mm to 2000 mm. Painting according to the customer's specification is available on order.

### Advantages

- No glass misting
- Optimal ventilation
- No heat losses
- Low pressure drop
- Prevents the descent of cold air along windows
- Does not cause heating of air near the windows even in the sunshine
- Easy installation



## Versions

single slot LD-16N/1

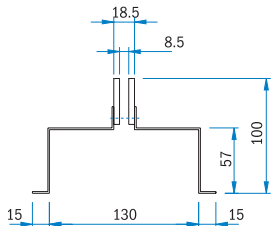

two slots LD-16N/2

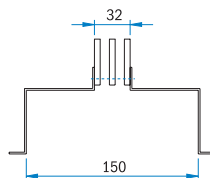

three slots LD-16N/3

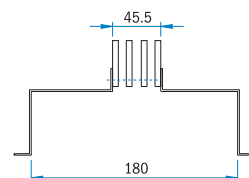

four slots LD-16N/4

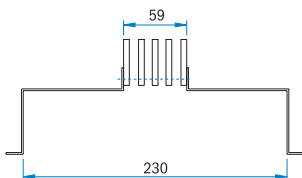

five slots LD-16N/5

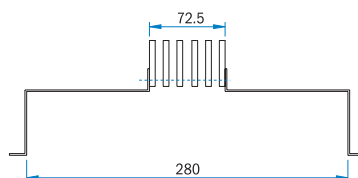

six slots LD-16N/6

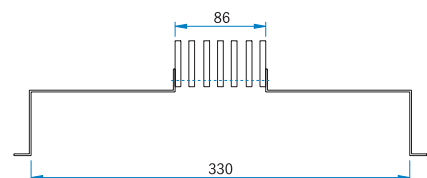

### Installation method

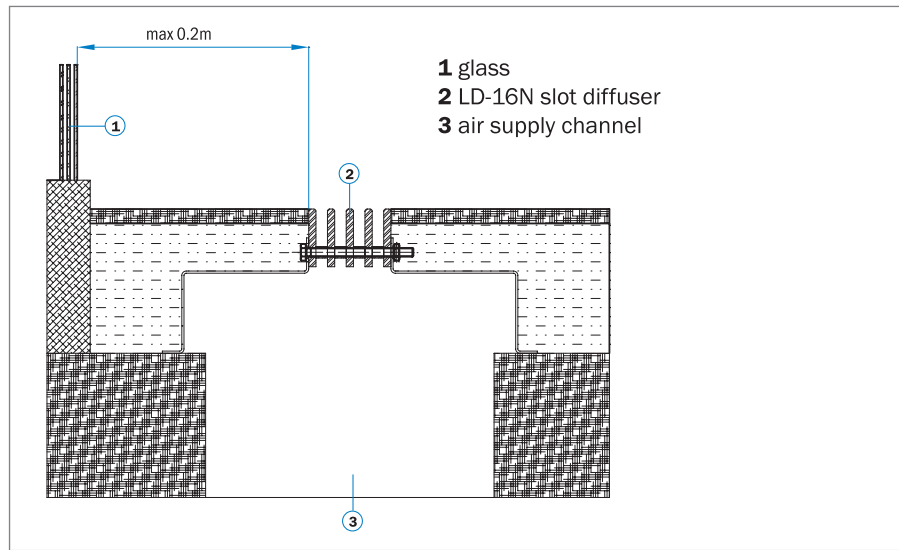

### Fast selection diagram

$L_{WA} < 35 \text{ dB(A)}$ ;  $V_{ef} = 2,5 \text{ m/s}$ ;  $\Delta p_t = 16 \text{ Pa}$

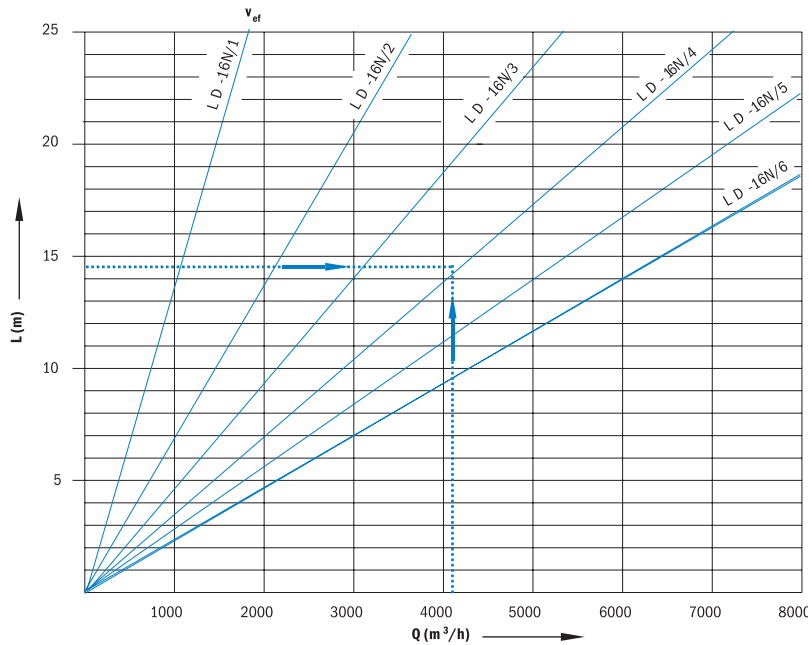

### Example

The available floor area next to the glass surface is 15 m in length. The calculated supplied air flow rate is 4000 m<sup>3</sup>/h. From the diagram, the type:  
LD-16N/3 L=15m is selected.

- Q (m<sup>3</sup>/h)** Air flow rate
- L<sub>WA</sub> (dB(A))** Sound power level
- Δp<sub>t</sub> (Pa)** Pressure drop
- L (m)** Slot diffuser length
- v<sub>ef</sub> (m/s)** Effective air velocity

### Ordering key

**LD-16N / 1 / L / n**

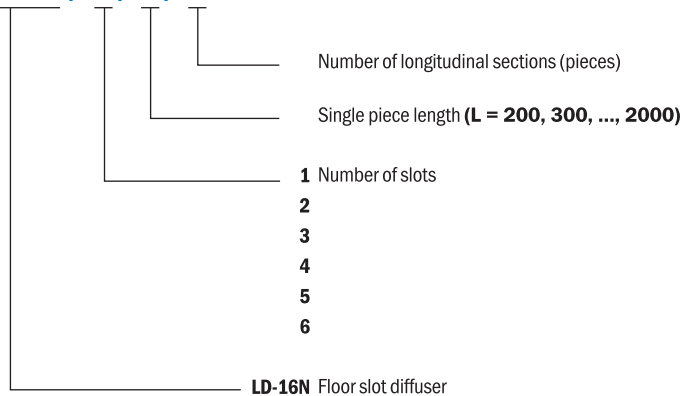

**Note:**

Standard colour is RAL 9010.